



# Product Selection Guide



Smart Home  
4G VoLTE Intercom  
Access Control

## Single Station Smoke Detector with 4G Communicator

- ★ Integrated 4G (3G or 2G) communicator
- ★ No external power adapter needed
- ★ Simple to install, no installation fee
- ★ Suitable for house, company, villa, machineroom, department and so on.



4G Smoke Detector provides a sufficient alarm for fire without the need for additional cables or fixed telephone lines. The smoke detector warns upon smoke with a local siren and a 4G communicator report to the set contact persons.



Due to the low power design the 4G communicator runs on a Lithium battery for more than one year. Clients will be able to remove the smoke chamber to clean and save on maintenance time. The smoke detector can use up to 10 years.



**Gainwise**

# 4G Smoke Detectors

## Feature

- ▲ 3 destination phone numbers
- ▲ SMS and Call upon detecting the smoke(4G:only SMS)
- ▲ SMS at low battery
- ▲ SMS programming
- ▲ Programmable to send SMS Reports on your schedule
- ▲ External RF module for received another RF smoke detectors.

## Application

- ▲ Standalone wireless fire alert system
- ▲ Used by insurance companies for quick fire alarm system
- ▲ Used by estate companies as temporary fire alarm system
- ▲ Architects and contractors who prefer a wireless system

## Model

- ▲ SS1801-3G: 2G/ 3G Fallback
- ▲ SS1801-4G: LTE Cat 1 and 2G / 3G Fallback

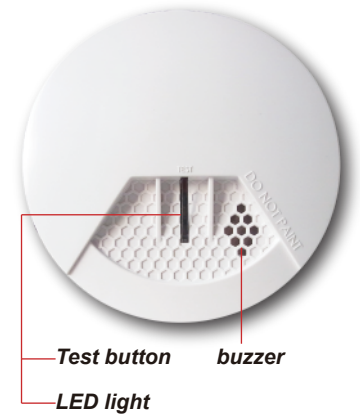

## 4G Smoke Detectors Technical data

3G Smoke Detector Module	SS1801-3G: Five Bands UMTS (WCDMA/FDD) Bands: 800, 850, 900, 1900 and 2100 MHz Quad-Band GSM Bands: 850, 900, 1800 and 1900 MHz
4G Smoke Detector Module	SS1801-4G-E: Penta-Band LTE: Bands 1, 3, 8, 20, 28*(700*, 800, 900, 1800, 2100 MHz), Dual-Band GSM 900and 1800 MHz SS1801-4G-US: Quad-Band LTE: Bands 2, 4, 5, 12 (700, 850,1700/2100 (AWS) and 1900 MHz), Tri-Band UMTS: Bands 5,4, 2 (WCDMA/FDD 850, 1700/2100 (AWS) and 1900 MHz) SS1801-4G-AUS: Quad-Band LTE: Bands 3, 5, 8, 28 (1800, 850,900, 700 MHz), Tri-Band UMTS: Bands 1, 5, 8(WCDMA/FDD 2100, 850, 900 MHz)
Accessories	Battery : Lithium CR 2/3 A
Smoke Detector Approval	EN14604 CPR,UL217 CPR,UL268
Accessories	CR123A (3 years)
Battery Power	Rating Voltage:DC 3V for lithium battery
Sensitivity & Alarm Pattern UL217	1.31%ft~2.28%/ft ; Temporal Three Pattern
Sensitivity & Alarm Pattern EN14604	0.091 dB/m~0.149 dB/m, Temporal Three Pattern
Heat Sensitivity & Alarm Pattern	57°C~65°C ; Temporal three Pattern
Relative Humidity	10% to 85% RH
Temperature Range	0°C to 50°C (32°F to 120°F)
Dimension	120mm (D) x 53mm (H)

## light Control System

SHL1021 is a light control unit which provides 2 loops for the light. User can build own wireless remote light switch system. It can work well with the present switches and is easy installed for you.

It provides two relays which can support loop load up to 230V/10A and there are different remote switch panels suitable for the SHL100 light control unit.

Specification:

- ★ Input power 90-230 VAC
- ★ 2 loop relays
- ★ 2 LED indicators
- ★ 2 switch buttons
- ★ RF frequency: 433.93MHz
- ★ Customize 315M / 866M / 906MHz)
- ★ Dimension : 64 x 56.3 x 21 mm

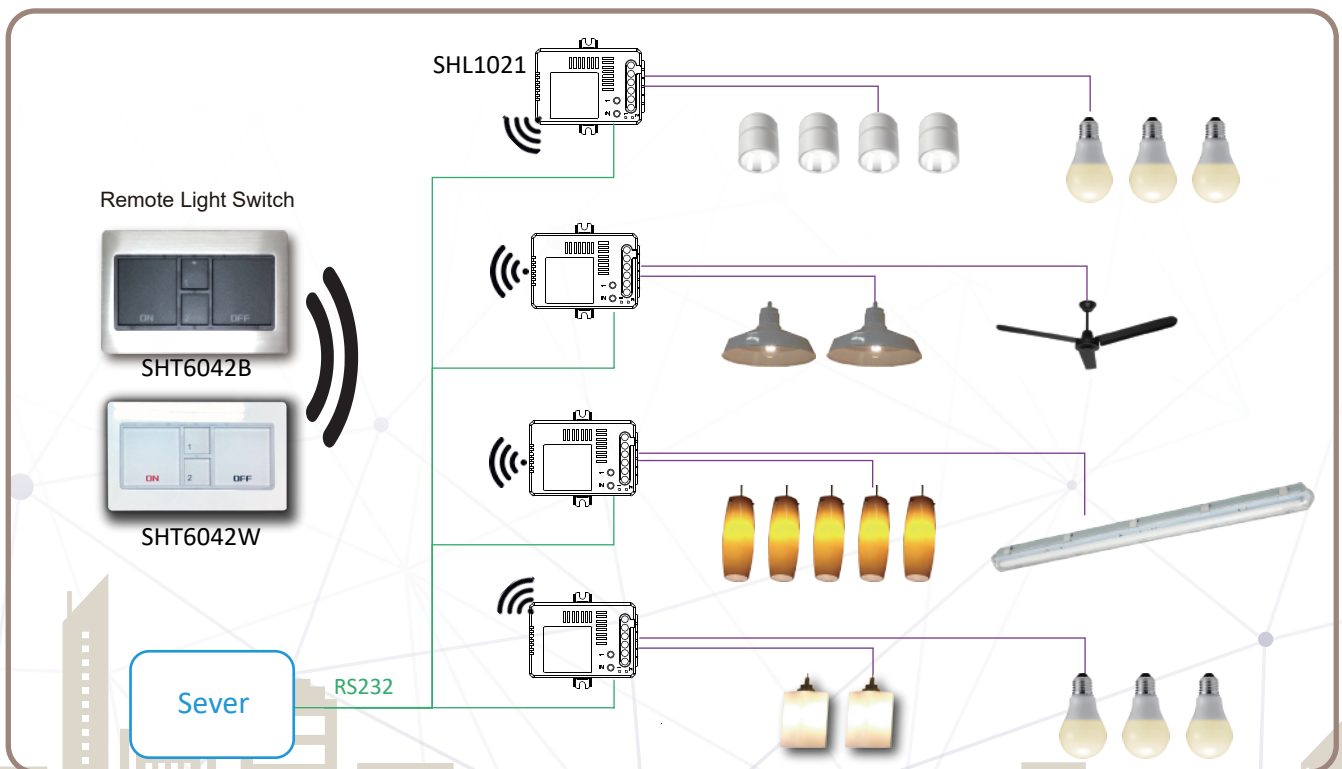



# Wireless Smart Home

## Home Security System



SHT5661

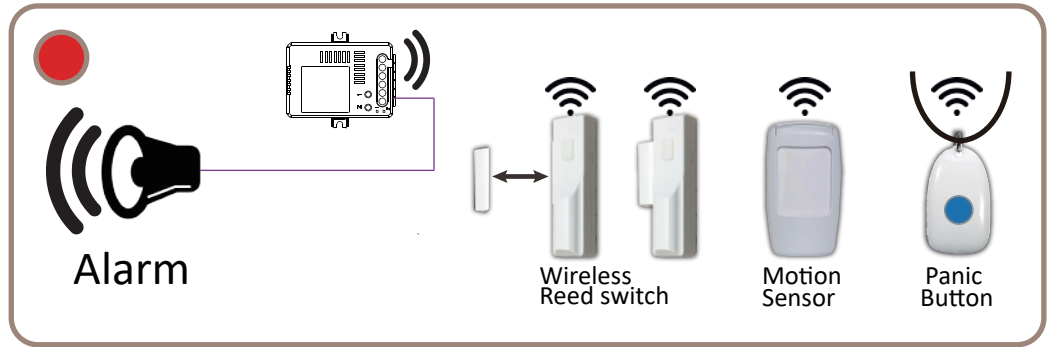
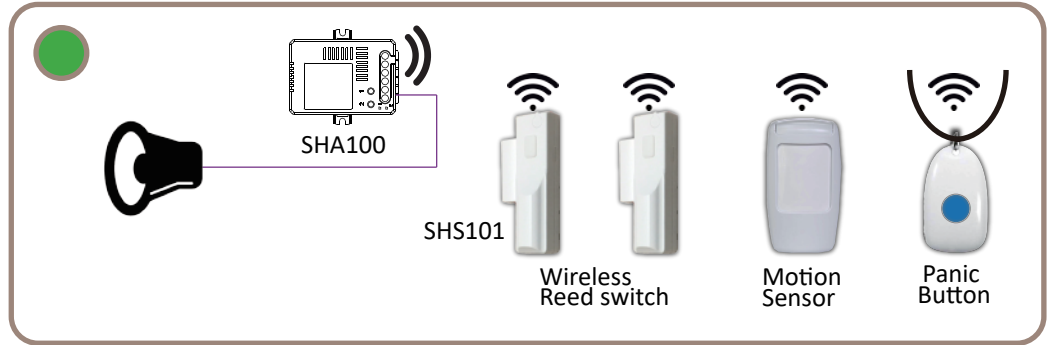

## Garage Door Controller





# Fixed Wireless Terminal (FWT)

## 2G | 3G | 4G FWT

With Fixed Wireless Terminals enterprises can benefit from substantial cost savings using Least Cost Routing (LCR) with the terminal connected to PBX. This enables turning fixed-to-mobile into mobile-to-mobile calls.

### NEOS 3000

- ★ Connect the NEOS3000A-3G to an analog trunk of PABX or a standard phone
- ★ Make direct mobile to mobile phone call to replace the expensive PSTN to mobile phone call
- ★ Mobile Trunk and Back-up telephone line
- ★ Automatically take advantage of the lowest rate to reach the LCR
- ★ Wireless payphone application



**4G Model**  
**Supports VoLTE**

### NEOS 4000

- ★ 4 channels model
- ★ Call restricted
- ★ Save on call cost
- ★ Polarity Reversal
- ★ Time control
- ★ Rack mount / wall mount







# Fixed Wireless Terminal (FWT)

Be a mobile trunk



PLMN



## NEOS 3000

Module	NEOS3000A: 2G/3G   EHS6 NEOS3002: 2G/3G/4G   EC21
Phone port:	RJ-11 interface for POTS
Line port:	RJ-11 interface for PSTN
Power:	AC/DC adapter
LCM signal:	USB connector for liquid crystal display module (optional)
Dimensions:	160 (H)x 120(W) x 27(D)mm
Weight	280g
Packaging	1 unit/box and 20 units/carton
	SMA antenna connector
	USB B type interface for data transmission

## NEOS 4000

Module	NEOS4000: 2G/3G   EHS6
Phone interfaces	Impedance:600Ω or AU 220Ω+820Ω//120nF or others Line current:24mA
Dimensions and Weight	240*164*43mm 966g
Connectors	PHONE PORT:P1,P2,P3,P4 RJ11 interface for POTS interface DC12V:12VDC power jack ANT1,ANT2,ANT3,ANT4:SMA plug female(50ohm) SIM1,SIM2,SIM3,SIM4:SIM card connector
LED indicators	Power   Status   Mobile   Hook(CPE)
Antenna(included)	SMA magent antenna(3meter)
Environment	Operating:-10°C~50°C Storage:-40°C~60°C Humidity:5%~95%
AC to DC swithing power supply(included)	AC input:100~240VAC,50/60Hz DCoutput:DC12V/3A AValiable plug:US,EU,AU,UK



# 2G | 3G | 4G Audio Intercom

## Single | 8 Buttons | Multi-Residents

### Feature

- ★ Answer the door intercom and talk with visitor from anywhere anytime
- ★ Calls up to 3 numbers whatever landline or mobile
- ★ Open the gate from anywhere in the world
- ★ Ring intercom to open the door (1150 numbers)
- ★ No wiring installation fee
- ★ Anti-Vandal and aluminum design
- ★ Flush mount and surface mount design
- ★ Simple to setup by PC / SMS /APP
- ★ Check log via SMS/ Email
- ★ For use up to 200 apartments
- ★ 384 user PIN codes for access control
- ★ User selectable 1-14 digit PIN codes
- ★ Blue backlight keypad is easy to operate at night

( ★:Only **Multi-Residents** )



**4G Model**  
**Supports VOLTE**

**VOLTE**  
Voice Over LTE



**Gainwise**

## 2G | 3G | 4G Audio Intercom

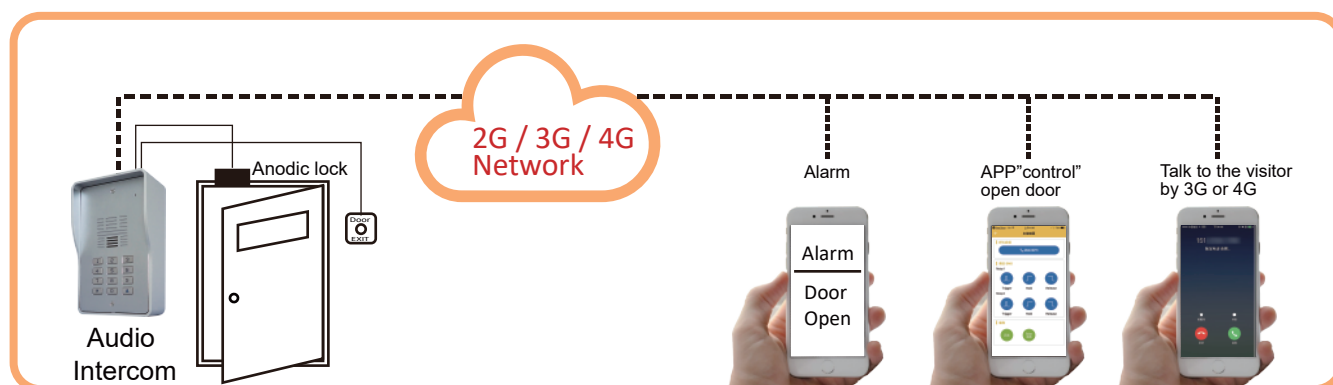

### Application

- ▲ When the door is cracked open by a burglar, the GSM intercom will notify the user by SMS alert.
- ▲ The 3G intercom is also ideal for vacation homes! when your tenants arrive, they simply press the keypad password to gain entry to your property.

### 2G | 3G | 4G Audio Intercom Comparison table

Model	SS1603-01 / SS1808-01	SS1603-08 / SS1808-08	SS1603-12 / SS1808-12
Households	1	8	200
Call out numbers	3	24(8X3)	600(200x3)
Open the door via PIN code	NO	NO	YES(384)
Name tag	YES	YES	NO
Call List Report	YES	YES	YES
Open door (sms/app)	YES	YES	YES
SMS Alerts if cracked	YES	YES	YES
Face plate	180(H) x 109(W)mm		
Dimension	189(H) x 118(W) x 65(D)mm		
Module	SS1603:2G/3G   EHS6 SS1808:2G/3G/4G   EC21		
SIM card type	Micro-SIM		
Operating Voltage	12 to 24 Volt AC/DC		
Setup by	PC / SMS /APP		
Design	Anti-Vandal and aluminum design		



## 2G | 3G | 4G Audio Intercom

### Detached House

#### Feature

- ★ Answer the door intercom and talk with visitor anywhere anytime
- ★ Calls up to 3 numbers whatever landline or mobile
- ★ Open the gate from anywhere in the world
- ★ 1150 user caller ID access control by free call
- ★ No wiring installation fee
- ★ Simple to setup by SMS or APP
- ★ Anti-Vandal and stainless steel design
- ★ Flush mount and surface mount design



4G Model

Supports VoLTE

**VoLTE**  
Voice Over LTE

### Gooseneck Pole Mount 3G | 4G Intercom With Keypad

#### Feature

- ★ Ideal for driveway gates
- ★ Answer the door intercom and talk with visitor anywhere anytime
- ★ 1150 user caller ID access control by free call
- ★ 384 user PIN codes access control from keypad
- ★ Optional for calling 1 guardroom or 200 residents





## 2G | 3G | 4G Audio Intercom

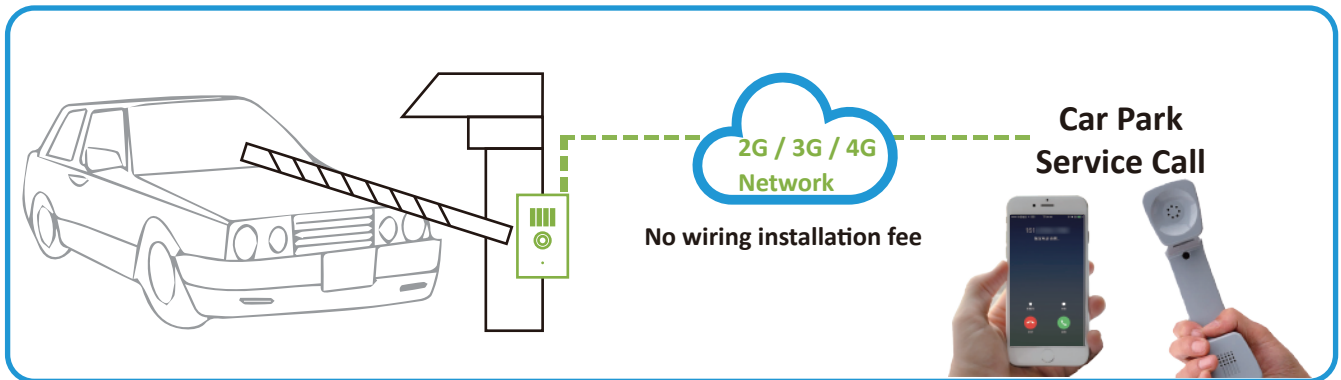

### Application

- ▲ Taxi Free Phone designed for all weather and anti-vandal use. Own your location! Uses a SIM card and calls the taxi office phone number when the call button is pressed.
- ▲ Press the GSM intercom call button and it will automatically connect you to the car park service enter for help.

### 2G | 3G | 4G Audio Intercom Comparison table

Model	SS91B / SS1704 / SS1804	SS1404	SS1704O-K12H / SS1804O-K12H
Call out numbers	3	3	3
Open the door via PIN code	NO	NO	YES(384)
Call List Report	YES	YES	YES
Relay control	2	1	2
SMS Alerts if cracked	YES	YES	YES
Dimension	174(H) x 113(W) x 65(D) mm	164(H) x 81(W) x 75(D) mm	260(H) x 160(W) x 120(D) mm
Module	SS91B: 2G   BGS2 SS1704: 2G/3G   EHS6 SS1804: 2G/3G/4G   EC21	2G/3G   SIM5215	SS1704O-K12H :2G/3G   EHS6 SS1804O-K12H :2G/3G/4G   EC21
SIM Card type	Mini-SIM		
Operating Voltage	12 to 24 Volt AC/DC		
Setup by	SMS /APP		



# WiFi Video Intercom

## Video & Door Control

### Feature

- ★ Real time two ways audio communication
- ★ Control the electronic door latch by APP
- ★ Aluminum material case. IP65 outdoor waterproof.
- ★ 10dB WiFi antenna for longer distance.
- ★ Supports WiFi (IEEE8012.11b/g/n) & support lan
- ★ Utilizing P2P technology, no DDNS, no port-forwarding
- ★ Answer Video Call through smartphone from remote place



### WiFi Intercom Specification

	TH-601W
Material	Metal Waterproof IP65
WiFi Distance	3walls+30m (10DB antenna)
Resolution Compression	720P 1080x720
Tamper alarm	Tamper alarm
Record	Record on TF card in dvice (can 24 hours protect your house)
Can record the door area all the time	Yes Like built-in DVR
Full Duplex	Full Duplex (2 way same time)
Audio Smooth when network not good	patent audio priority technology and video auto drop technology
Real color	IR-CUT real-color
Door Chime	Ring to door chime
Open lock	Yes
Night Vision	Yes

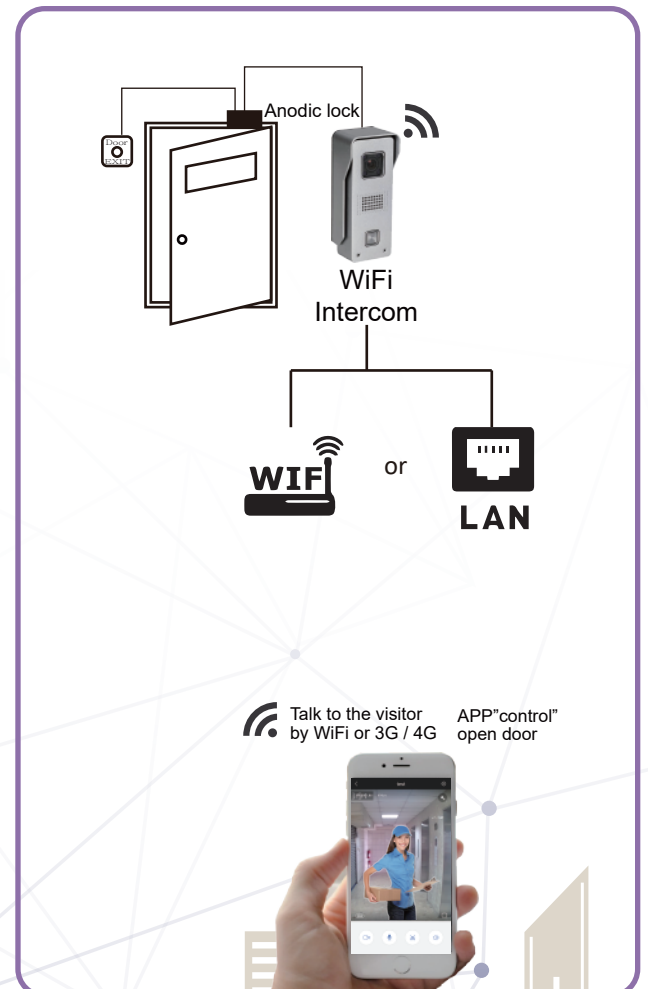



**Gainwise**

# WiFi Video Intercom

## Intercom with battery

### Feature

- ★ Low-power wireless video intercom doorbell
- ★ WIFI support 802.11 b/g/n
- ★ 1280\*720 image transmission is clear and stable
- ★ Two-way intercom, with echo cancellation
- ★ 2 regular batteries can be used for 3-6 months



### WiFi Intercom Specification

Model	ZC-IP02S
Master chip	Hi3518E
Sensor size	1/4 CMOS
Resolution	1280*720
Lens angle	Diagonal 166°
Infrared light	6 infrared lamps 850nm
WIFI	802.11 b/g/n
Audio	Two-way intercom, with echo cancellation
Motion Detection	PIR infrared detection
Wake-up method	PIR detection wakes up, mobile phone wakes up
Push	Speed push within 1S
Power consumption	Standby current 250uA, working current 170mA charging
Recording	SD card (optional) recording, on-demand
battery	2 sections of normal 18650 battery without protection (15 minutes of normal wake-up every day, 3-6 months) (optional)

### **Gate Opener**

#### **Feature**

- ★ Open the door via Call/SMS remotely
- ★ Free Call to access by Caller ID (1152 users)
- ★ Log records sent via SMS/Email
- ★ SMS alert when input is triggered
- ★ Supports 2 output relays and 3 input triggers



### **3G Keypad Opener**

#### **Feature**

- ★ Open the door via PIN code or Call/SMS remotely
- ★ 384 user PIN codes
- ★ Free Call to access by Caller ID (1152 users)
- ★ Log records sent via SMS/Email
- ★ SMS alert when input is triggered
- ★ Support 2 output relays and 3 input triggers
- ★ Wrong PIN code entry limit and will emit alert sound
- ★ Anti-Vandal and stainless steel keypad with blue backlight design







## 2G | 3G | 4G Access controller

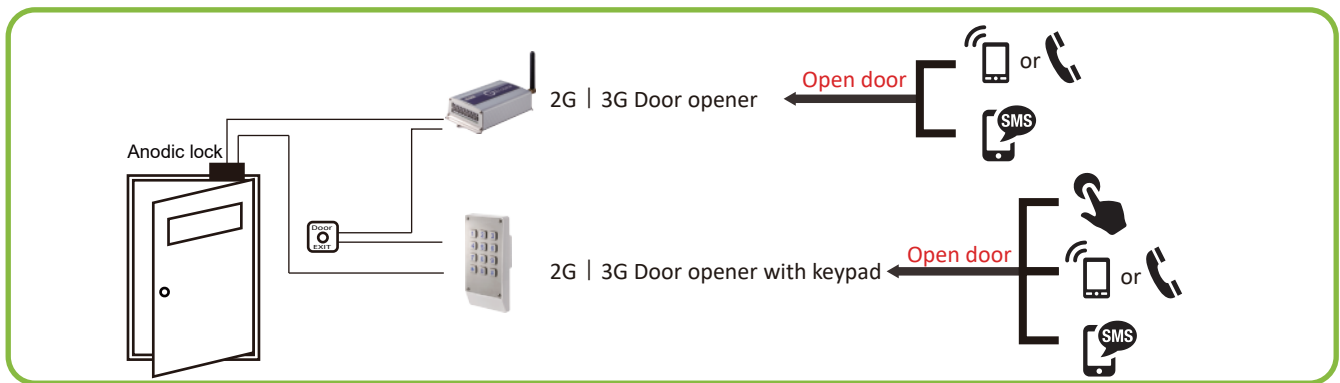

### 2G | 3G | 4G Access controller Comparison table

Model	SS1106 / SS1706 / SS1806	SS1401D2
Open the door via PIN code	NO	YES(384)
Call List Report	YES	YES
Inputs	3	0
Outputs	2	2
SMS Alerts if cracked	YES	YES
Dimension	90(H) x 60(W) x 27(D) mm	164(H) x 81(W) x 75(D) mm
Module	SS1106:2G   BGS2 SS1706:2G/3G   EHS6 SS1806:2G/3G/4G   EC21	SS1401D2:2G/3G   SIM5215
SIM Card type	Mini-SIM	
Operating Voltage	12 to 24 Volt AC/DC	
Setup by	SMS /APP	

## Accessories



	Surface Mount Box			Lighted Directory
Model	DC-020A	DC-024A	DC-029A	SS1800-01
Suitable for	SS91B / SS1704 / SS1804	SS1404 / SS1401	SS1603 / SS1808(series)	SS1603-12 / SS1808-12
Dimension (H)x(W)x(D)	174x 113 x 65 (mm)	164 x 81 x 75 (mm)	189 x 118 x 65 (mm)	189 x 118 x 65 (mm)

## Door Latches & Egress Button



Electric silent Lock  
with exit button



Electric Bolt



Electric Strike Lock



Magnetic lock



Egress Button



Egress Button



Egress Button



Magnetic reed switch

### Contact

✉ gainwise-sales@gainwise.com.tw

☎ +886-6-3127675

🏠 10F-4, No.12, Zhonghua Rd., Yongkang Dist., Tainan City 71069, Taiwan